

Metal Glaze™ Cylindrical Surface Mount Power Resistors

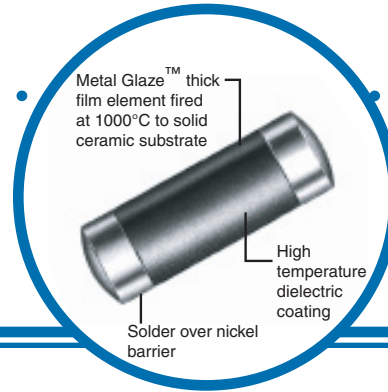

CHP Series

- Up to 2 watts
- Up to 1000 volts
- 0.2 ohm to 2.2 megohm range
- RoHS-compliant version available
- 150°C maximum operating temperature



Electrical Data

Size Code ¹	Industry Footprint	IRC Type	Maximum Power Rating	Working Voltage ²	Maximum Voltage	Resistance Range (ohms) ³	Tolerance (±%) ³	TCR (ppm/°C) ³	Product Category
B	1206	CHP 1/8	1/4W @ 70°C	200	400	0.1 to 0.99	1, 2, 5	100	Low Range
						1.0 to 1.0 M	1, 2, 5	50, 100	Standard
						20 to 348K	0.25, 0.5	50, 100	Tight Tolerance
D	2010	CHP 1/2	1/2W @ 70°C	300	600	0.1 to 0.99	1, 2, 5	100	Low Range
						1.0 to 348K	1, 2, 5	50, 100	Standard
F	2512	CHP 1	1W @ 70°C	350	700	0.1 to 0.99	1, 2, 5	100	Low Range
						1.0 to 2.21M	1, 2, 5	50, 100	Standard
						20 to 348K	0.25, 0.5	50, 100	Tight Tolerance
H	3610	CHP 2	2W @ 25°C 1.33W @ 70°C	500	1000	0.2 to 0.99	1, 2, 5	100	Low Range
						1.0 to 2.21M	1, 2, 5	50, 100	Standard

¹See page 8 for product dimensions, recommended solder pads, and standard packaging. ²Not to exceed $\sqrt{P \times R}$ ³Consult factory for tighter TCR, tolerance, or resistance values.

Environmental Data







Characteristics	Maximum Change	Test Method
Temperature Coefficient	As specified	MIL-R-55342E Par 4.7.9 (-55°C + 125°C)
Thermal Shock	±0.5% + 0.01 ohm	MIL-R-55342E Par 4.7.3 (-65°C + 150°C, 5 cycles)
Low Temperature Operation	±0.25% + 0.01 ohm	MIL-R-55342E Par 4.7.4 (-65°C @ working voltage)
Short Time Overload	±0.5% + 0.01 ohm ±1% for R>100K ohm	MIL-R-55342E Par 4.7.5 2.5 x $\sqrt{\quad}$ for 5 seconds
High Temperature Exposure	±0.5% + 0.01 ohm	MIL-R-55342E Par 4.7.6 (-150°C for 100 hours)
Resistance to Bonding	±0.25% + 0.01 ohm	MIL-R-55342E Par 4.7.7 (Reflow soldered to board at 260°C for 10 seconds)
Exposure	95% minimum coverage	MIL-STD-202, Method 208 (245°C for 5 seconds)
Solderability	±0.5% + 0.01 ohm	MIL-R-55342E Par 4.7.8 (10 cycles, total 240 hours)
Moisture Resistance	±0.5% + 0.01 ohm	MIL-R-55342E Par 4.7.10 (2000 hours at 70°C intermittent)
Life Test Terminal Adhesion Strength	±1% + 0.01 ohm no mechanical damage	1200 gram push from underside of mounted chip for 60 seconds
	±1% + 0.01 ohm no mechanical damage	Chip mounted in center of 90mm long board, deflected 1mm so as to exert pull on chip contacts for 5 seconds

General Note

IRC reserves the right to make changes in product specification without notice or liability. All information is subject to IRC's own data and is considered accurate at time of going to print.

Metal Glaze™ Cylindrical Surface Mount Power Resistors

Physical Data

Size Code	Industry Footprint	Actual Size	Dimensions (Inches and (mm))		
			L	W	C
					
B	1206		0.128 ± 0.007 (3.25 ± 0.18)	0.057 ± 0.006 (1.45 ± 0.15)	0.020 ± 0.010 (0.51 ± 0.25)
C	1206		0.128 ± 0.007 (3.25 ± 0.18)	0.063 ± 0.010 (1.60 ± 0.25)	0.020 ± 0.010 (0.51 ± 0.25)
D	2010		0.200 ± 0.010 (5.08 ± 0.25)	0.079 ± 0.006 (2.01 ± 0.15)	0.030 ± 0.010 (0.761 ± 0.25)
E	2010		0.200 ± 0.010 (5.08 ± 0.25)	0.105 ± 0.006 (2.67 ± 0.15)	0.040 ± 0.015 (1.02 ± 0.38)
F	2512		0.251 ± 0.010 (6.38 ± 0.25)	0.079 ± 0.006 (2.01 ± 0.15)	0.040 ± 0.010 (1.02 ± 0.25)
H	3610		0.367 ± 0.010 (9.32 ± 0.25)	0.105 ± 0.006 (2.67 ± 0.15)	0.050 ± 0.010 (1.27 ± 0.25)

Recommended Solder Pad Dimensions (Reflow):

Size Code	Industry Footprint	Dimensions (Inches and (mm))					
		A	B	C	D	E	F
B & C	1206	0.076 (1.93)	0.093 (2.36)	0.058 (1.47)	0.098 (2.49)	0.032 (0.81)	0.211 (5.36)
D	2010	0.111 (2.82)	0.126 (3.20)	0.096 (2.44)	0.152 (3.86)	0.040 (1.02)	0.318 (8.08)
E	2010	0.170 (4.32)	0.160 (4.06)	0.072 (1.83)	0.132 (3.35)	0.044 (1.12)	0.412 (10.46)
F	2512	0.121 (3.07)	0.126 (3.20)	0.127 (3.23)	0.183 (4.65)	0.040 (1.02)	0.369 (9.37)
H	3610	0.170 (4.32)	0.160 (4.06)	0.213 (5.41)	0.273 (6.93)	0.044 (1.12)	0.553 (14.05)

Metal Glaze™ Cylindrical Surface Mount Power Resistors

Standard Reel Packaging per EIA-481:

Size Code	Industry Footprint	Reel Diameter*	Quantity Per Reel	Carrier Tape Width	Component Pitch
B & C	1206	7"	2,500 max.	8mm	4mm
		13"	10,000 max.		
D	2010	7"	1,500 max.	12mm	4mm
		13"	5,000 max.		
E	2010	7"	1,500 max.	12mm	4mm
		13"	5,000 max.		
F	2512	13"	5,000 max.	12mm	4mm
H	3610	7"	1,500 max.	24mm	4mm

*The 13" reel is considered standard and will be supplied unless otherwise specified.

Power Derating Curve

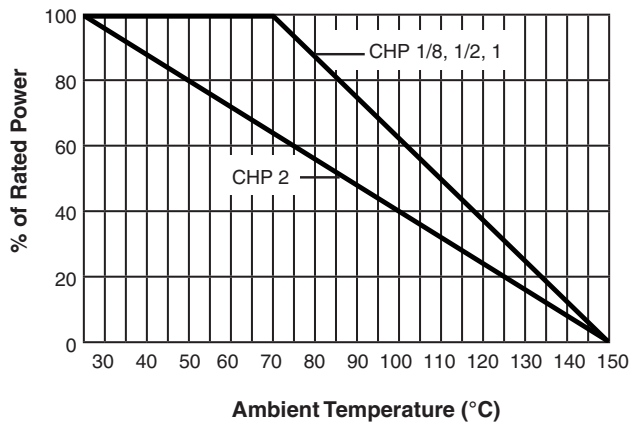

Repetitive Surge Curve

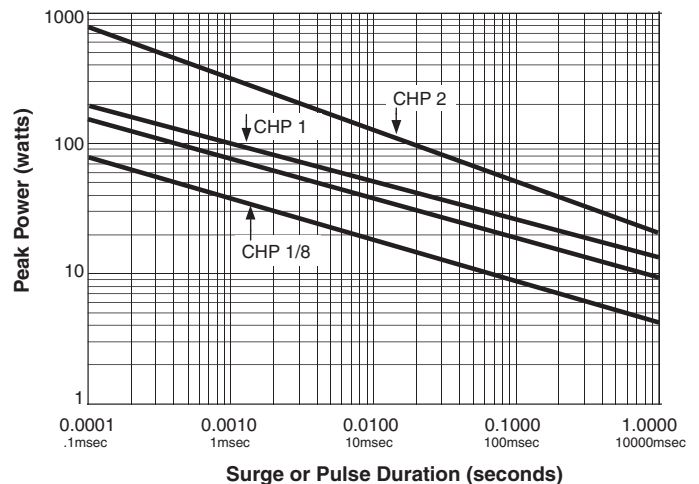

Note: Use for repetitive pulses where the average power dissipation is not to exceed the component rating at 70°C. Surge handling capacity for low-repetitive surges may be significantly greater than shown above. Contact factory for recommendations.

Ordering Data

Sample Part No. **CHP 1 - 100 2203 F 13 LF**

IRC Type
(CHP 1/8, CHP 1/2, CHP 1, or CHP 2)

Temperature Coefficient
(50 ppm, 100 ppm)

Resistance Value
(100 ohms and greater - First 3 significant digits plus 4th digit multiplier)
Example: 100 ohms = 1000, 1000 ohms = 1001, 150,000 ohms = 1503
(Less than 100 ohms - "R" is used to designate decimal)
Example: 51 ohms = 51R0, 1 ohm = 1R00, 0.25 ohms = R250

Tolerance
(C = 0.25%, D = 0.5%, F = 1.0%; G = 2.0%; J = 5.0%)

Packaging Code*
(BLK = Bulk, 7 = 7" Reel, 13 = 13" Reel)

Lead Free Construction